



# CUTIE TERMS GLOSSARY

## CUTIE:

A cutie is a 9" x 22" fabric strip.

## CUTIE COLLECTION:

A package of different lines of fabric in sets of 16 'cuties'.

## FAT 1/8:

The size of one piece of cutie fabric.

It measures 9" x 22"

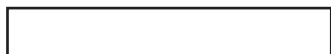

## FAT 1/4:

Double the width of a cutie. It measures 18" x 22".

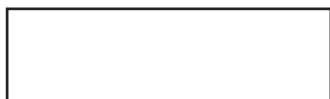

## FOUR PATCH:

Four squares sewn together, two by two.

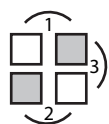

## FUSSY CUT:

Centering a specific motif in a pattern piece.



## HST:

Stands for Half Square Triangle.



## QST:

Stands for Quarter Square Triangle.



## HWOFF:

Stands for Half Width Of Fabric

## WOF:

Stands for Width Of Fabric.

## LOF:

Stands for Length Of Fabric.

## 1/4" SEAM ALLOWANCE:

In quilting, a shy 1/4" seam allowance is used. Set your machine and move needle on position to right. This allows for thickness of fabric and thread.

## PARTIAL SEAMING:

See page 2

## BORDERS:

The lengths we give in our patterns are the actual lengths with an accurate 1/4" seam allowance. You should measure your quilt before you cut your borders to make sure your numbers are the same. Adjust accordingly.

## BINDING:

See page 3

## Partial Seams

Partial seams are used when pieces added to a center unit are longer than the center unit. This technique involves sewing the first piece of fabric partially to another, then coming back at the end (of piecing the unit) to complete the initial seam.

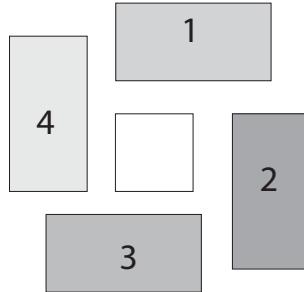

**1.** Lay piece 1 right sides together on the center square with pieces aligned at the top right corner. Using a  $\frac{1}{4}$ " seam allowance, begin sewing from roughly the middle of the center square, backstitch, then sew off the end of the pieces. Finger press the partial seam away from the center square.

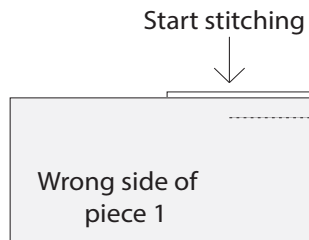

**2.** With right sides together, sew piece 2 to the right side, then piece 3 to the bottom, pressing seams away from the center square after each piece is added.

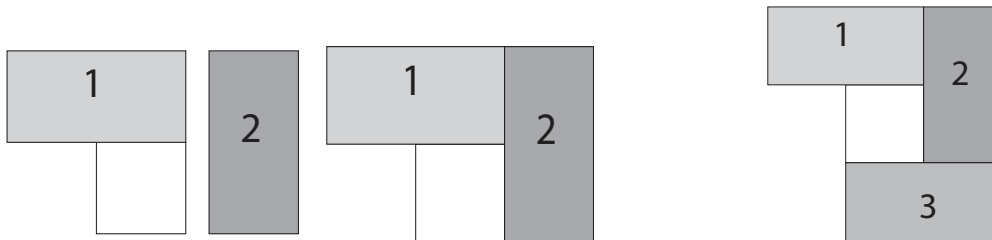

**3.** Fold piece 1 out of the way and sew piece 4 to the left side. Press seam away from the center square. Lay piece 1 back down, align raw edges, and complete the partial, piece 1 seam. Press the seam away from the center square.

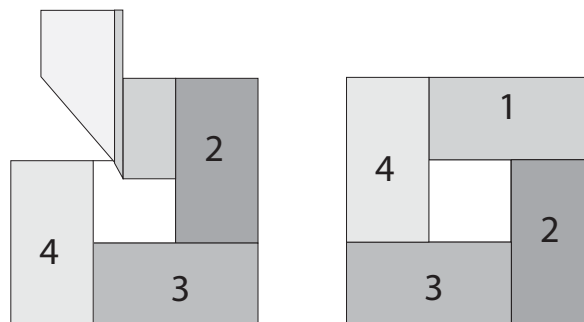

## Binding Your Quilt

### Making a Diagonally Pieced Binding Strip

**Note:** Binding strips are less noticeable and less bulky when sewn together diagonally.

1. Use the designated amount of 2 ½" wide binding strips from your project. Lay one strip, right sides together, on one end of another strip at a 90° angle. Draw a diagonal line between the points where the strips intersect. Sew on the drawn line, trim ¼" away from the stitch line, and press the seam open. Repeat with the remaining strips to make one long strip.

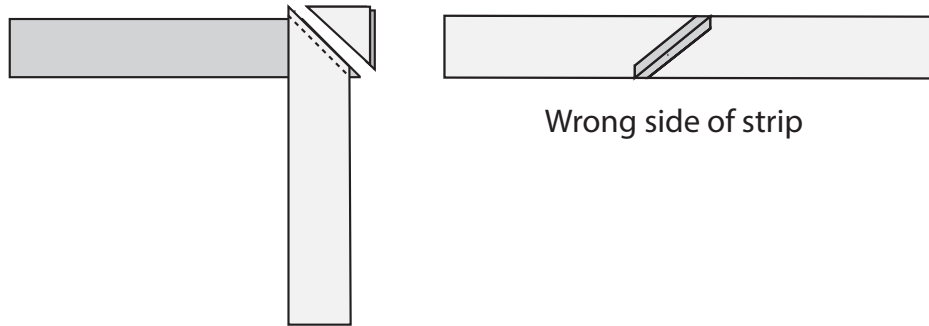

2. Fold the strip lengthwise in half, wrong sides together and press.

### Sewing the Binding to the Quilt Top

**Note:** Use a walking foot if possible.

1. Trim the outer edges of the quilt sandwich leaving approximately 1/8" of batting and backing extending beyond the edge of the quilt top. Start around the midpoint on one side of the quilt and align the raw edges of the binding with the raw edges of the quilt sandwich. Leave a 6" tail unsewn and begin stitching on the front side of the quilt top using a 3/8" seam allowance, backstitch to secure. Sew up to the first corner, stopping ¼" away from the edge, then turn it and sew off the edge to the point.

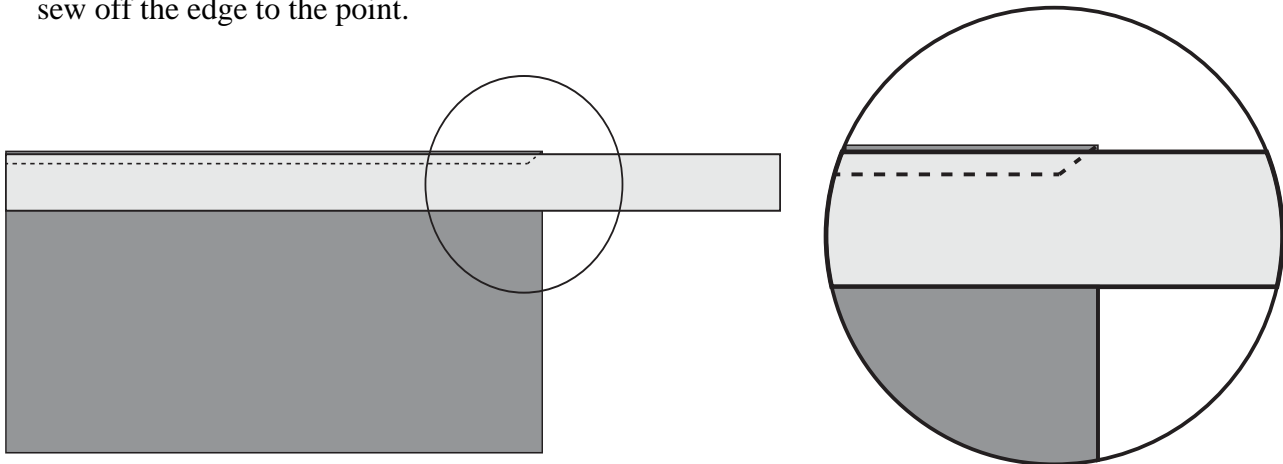

Remove the quilt from the machine. Fold the strip up at a 90° angle (so it's in line with the next side, creating a 45° angle at the corner) then back down over itself, aligning the raw edges of the binding to the adjacent side of the quilt top. Pin. Bring the quilt back to the machine and continue sewing along the second side, starting at the corner edge, stopping  $\frac{1}{4}$ " away from the next corner, and sewing off the edge to the point. Repeat to miter the corner. Continue in the same manner all the way around, mitering the corners as you go, and stopping 10" away from the starting point. Backstitch. Remove the quilt from the machine.

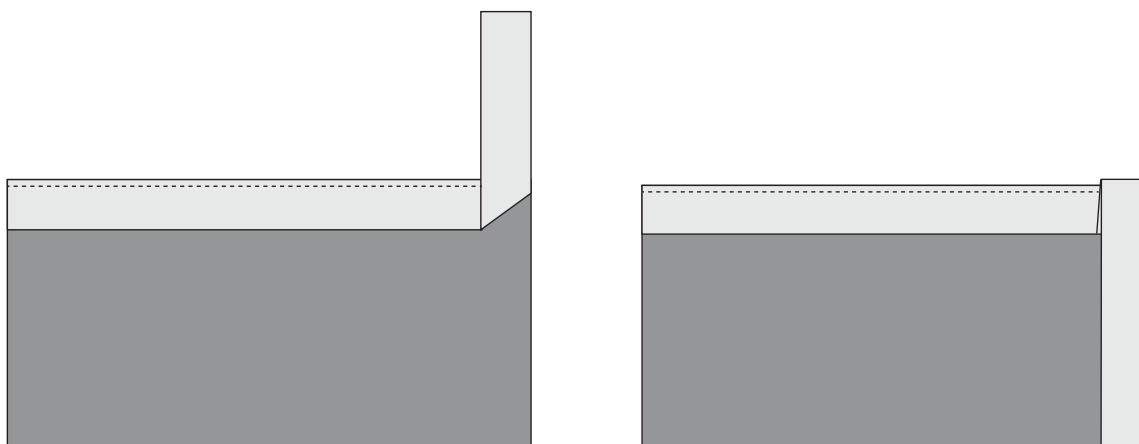

**2.** Lay the beginning tail of the binding along the unsewn 10" opening of the quilt top. Lay the ending tail on top so both ends overlap, then trim the tails so the overlap measures 2  $\frac{1}{2}$ ".

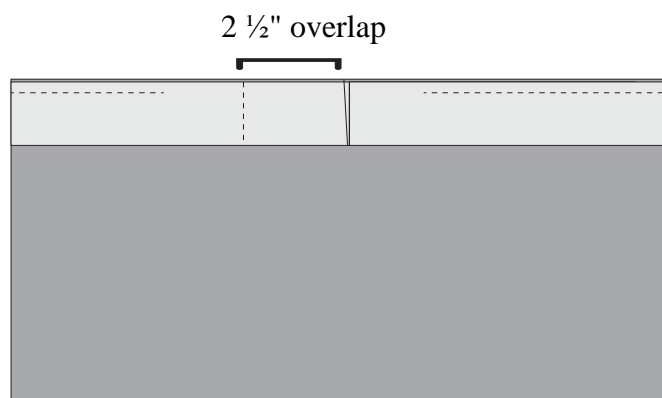

**3.** Open the folded binding ends, place them perpendicular (at a 90° angle) to each other with right sides together, and pin. Sew the ends together diagonally, stitching from one corner to the other. Trim the excess corner fabric, leaving a  $\frac{1}{4}$ " seam allowance and finger-press the seam open.

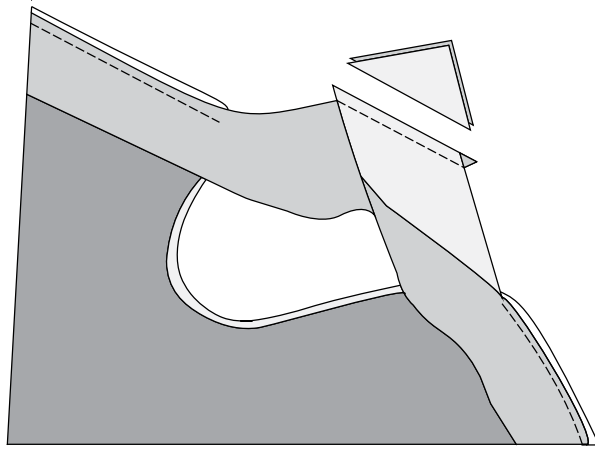

**4.** Refold the binding, position it along the 10" gap, and finish sewing it to the quilt top.

**5.** Fold the binding to the wrong side of the quilt top, enclosing the raw edges, and hand stitch in place on the back of the quilt.